

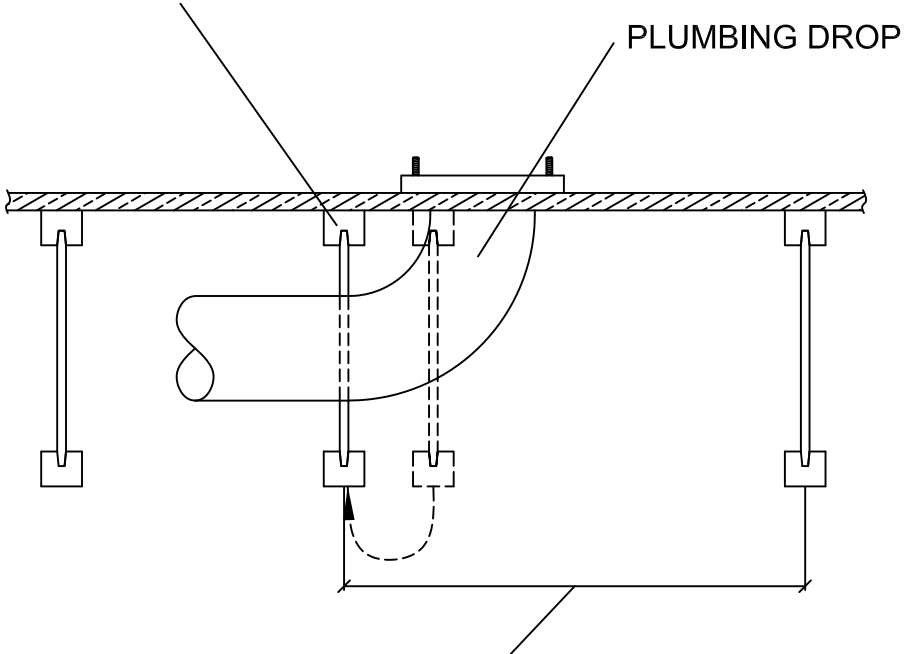

Weyerhaeuser prepared this drawing for the specification of Trus Joist products based on project information provided to us. This service is solely intended for product application assurance, and is not intended to document the need for a design professional as determined by the building codes. The designer of record and/or builder/framer is responsible to assure these drawings are compatible with the over all project.

Copyright 2019 Weyerhaeuser NR Company. All rights reserved. Any unauthorized copying or reproduction will constitute an infringement of copyright.

JOIST MAY BE SHIFTED UP TO 3". DO NOT DAMAGE JOIST FLANGES WHEN CUTTING PLUMBING DROP.



24" MAX SPACING BETWEEN JOISTS. ADDITIONAL JOIST MAY BE REQUIRED TO SUPPORT FLOOR PANEL EDGES IF PANEL SPAN RATING IS EXCEEDED.

INSTALLATION TIPS

- ALTERNATE OPTIONS INCLUDE INSTALLATION OF OFFSET TOILET FLANGE, OR JOIST HEADER OFF AROUND PLUMBING. REFER TO TB-319 FOR HEADER OFF DETAILS.
- ENSURE HOLES CUT INTO JOIST WEB COMPLY WITH TJI HOLE CHART, AVAILABLE IN TJ-4000 OR THE TJI FRAMERS POCKET GUIDE.
- USE CONSTRUCTION ADHESIVE AT ALL CONTACT SURFACES.

PLUMBING DROP DETAIL

EXPIRATION DATE: JANUARY 2025

PROJECT #:

SERVICE #:

SHEET:

NW-D223